

Trim Tab Installation with Electronic Sensors

Model Number: TTK1150EL, TTK1050EL, TTK950EL, TTK850EL, TTK750EL

Parts Included

- (2) Trim Tabs with Sensors
- (2) Hydraulic Pumps
- (2) Mounting Templates
- Harnesses - TTMWH & (2) - TTIWH
- Mounting Hardware
- Stainless steel hoses sold separately- 2 hoses required per tab

Mounting Tab Location

Available mounting area:

Before selecting a mounting location verify proper clearances inside (transom mounted components, etc) and outside (turning drive and propeller clearance) of the boat. **Do not** mount tabs in the chine area.

NOTE: The farther the tabs are between each other the better, this will allow you to achieve the maximum performance out of your tabs.

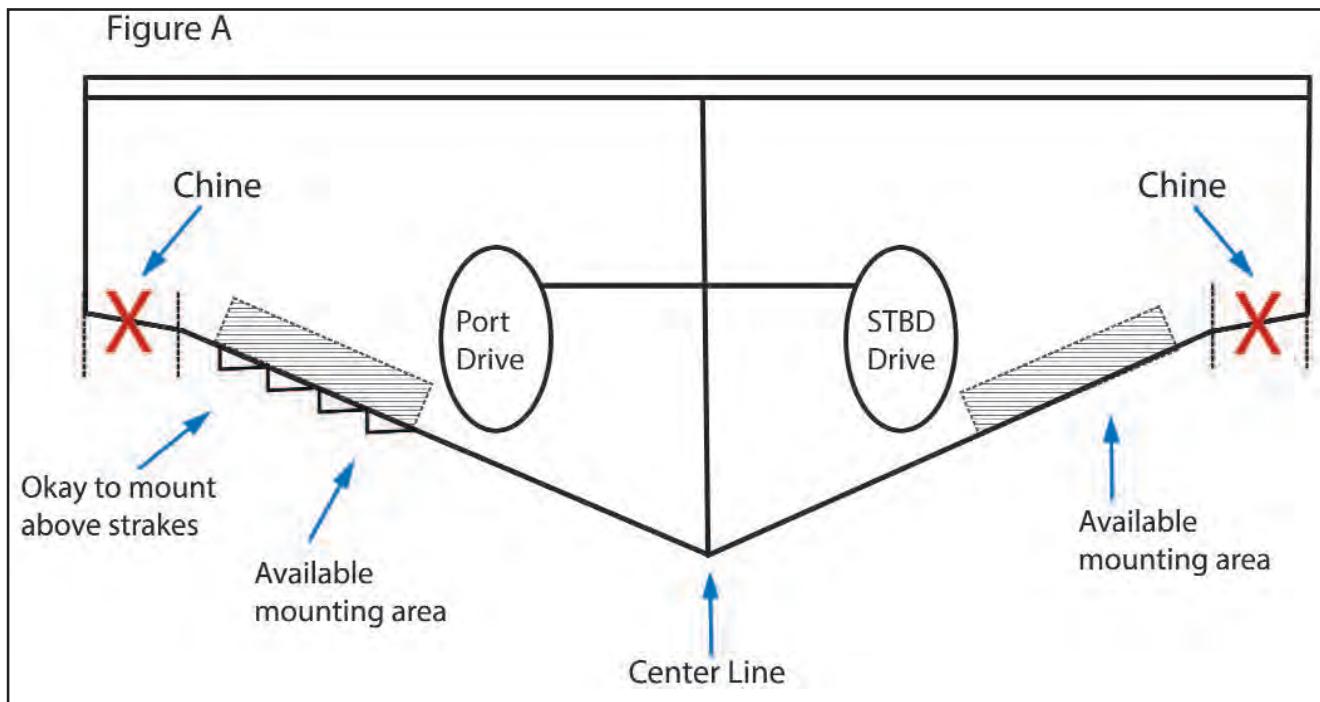

Billet Trim Tab Installation

Mounting tab location cont.

Transition of the hull to tabs:

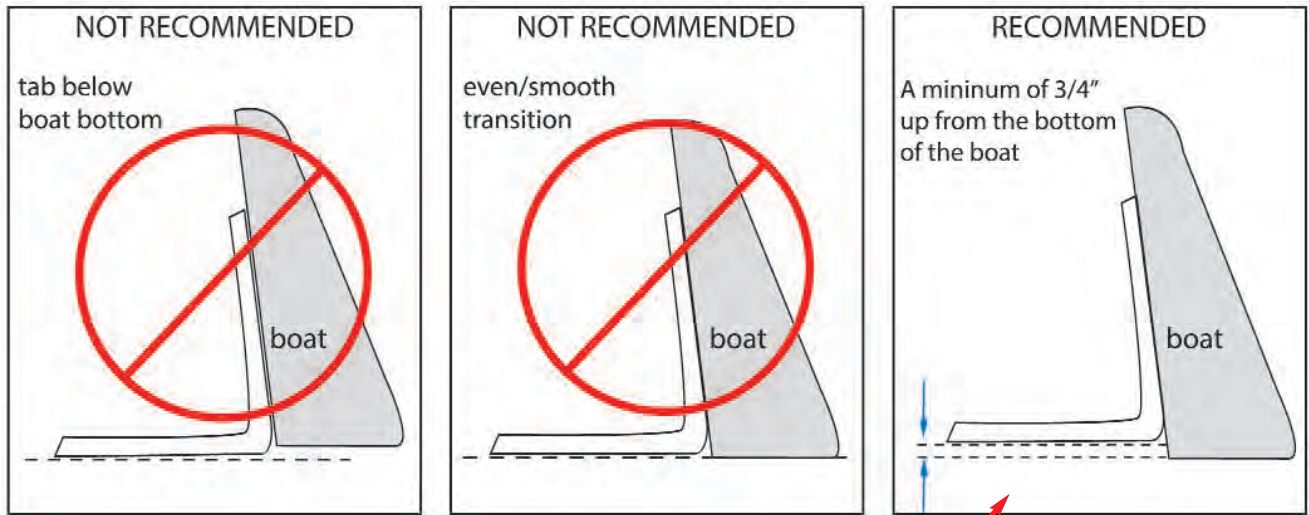

REV A

Recommended Transition:

Allows tab to be removed fully from the water flow underneath the boat while under way. Some applications may require the tab to be mounted even higher to be out of the water flow.

Billet Trim Tab Installation

Using the template:

Once the location is determined, use the **supplied template** for drilling holes.

The template will need to be printed on **11"x17" paper (minimum)**, template scale is 1:1. When printing make sure your print settings **do not resize the document**, keep it at 100% or disable any scale options.

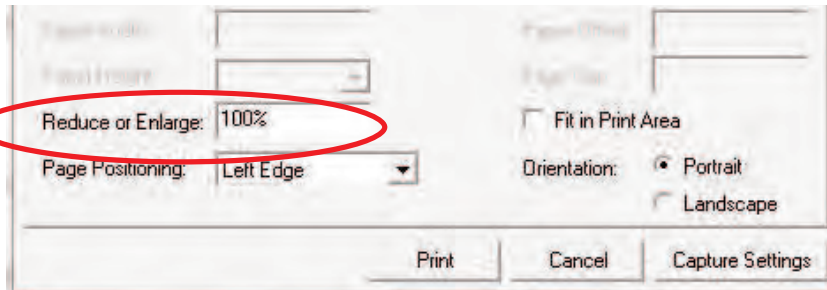

NOTE: PORT AND STARBOARD TEMPLATES ARE DIFFERENT

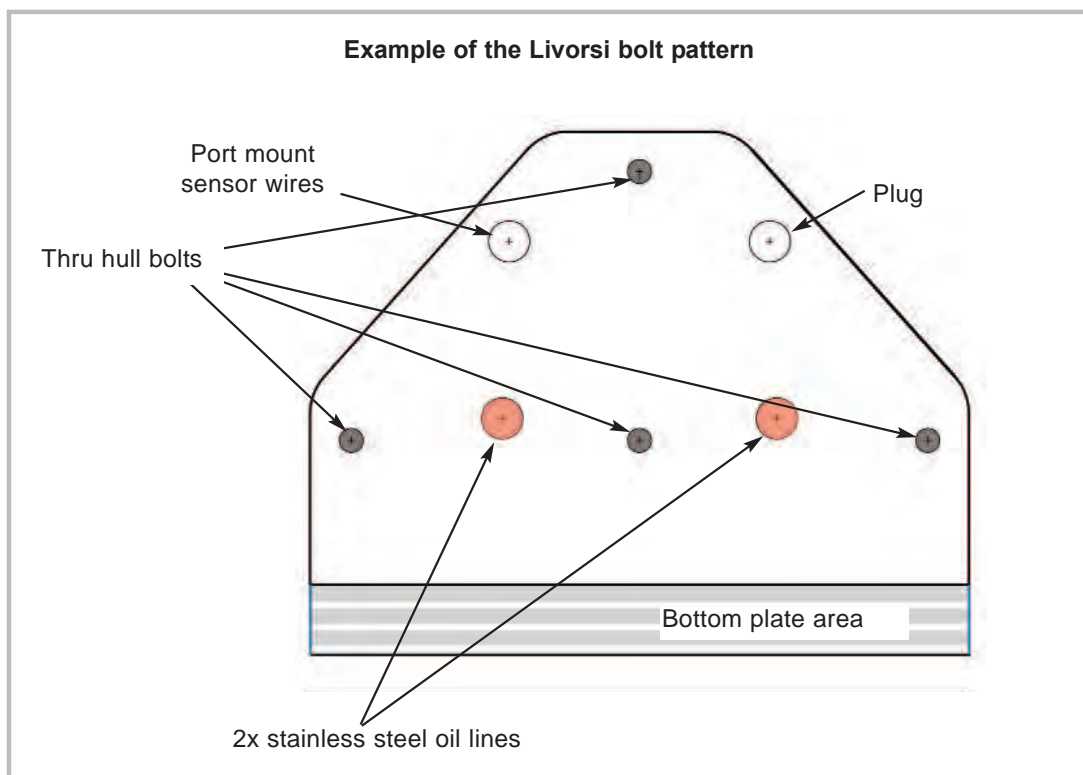

Depending on your tab model, if equipped with an electric sensor, only drill one hole for the wire access thru the transom.

Billet Trim Tab Installation

Mount the tab:

If the Livorsi Trim Tabs are replacing existing tabs, make sure to seal any unnecessary holes on the transom. Use a high quality marine sealer suitable for underwater use.

Recommended sealant: Marine Grade RTV / silicone sealant 4200 or 5200.

Use this same sealer and apply liberally around each fastener, indicator wires and between transom and upper trim plate. It is recommended to apply the same sealant to the inside of the boat.

You may want to apply a piece of tape to the ends of the hydraulic thru hull fittings to prevent debris from entering the openings.

If equipped with the electronic sensor carefully feed the sensor wires thru the transom.

Secure all mounting hardware.

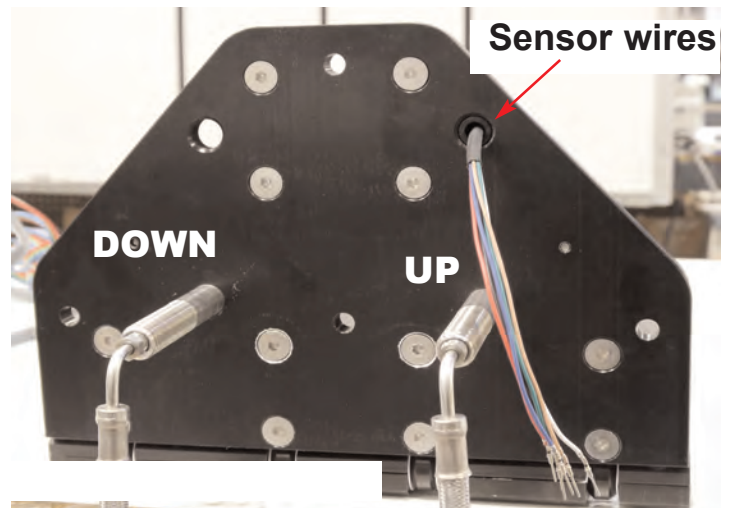
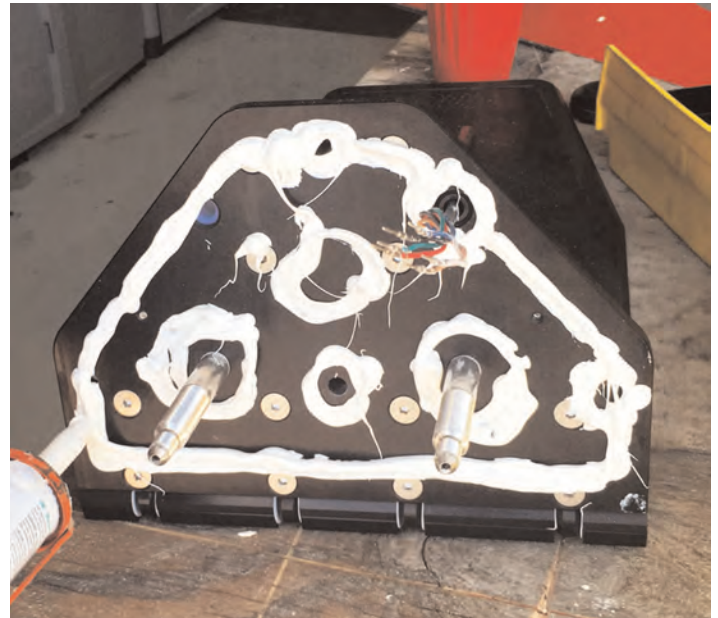

Back view of mounting plate

Installing the pumps and hydraulic lines:

Select the location to mount the hydraulic pumps.

NOTE: Keep pumps as level as possible.

Once mounted, route the hydraulic lines from the tab to the pump. Make sure hydraulic lines are routed and secured away from any moving components in the boat..

Billet Trim Tab Installation

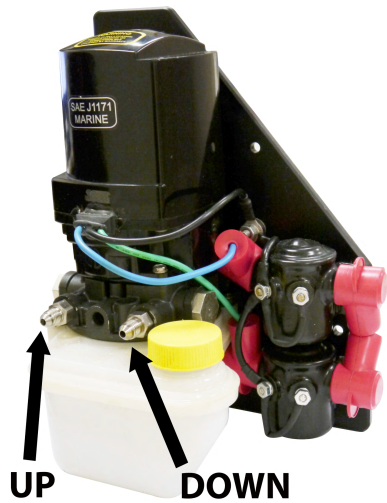

24 VOLT
See page 6 for wiring diagram

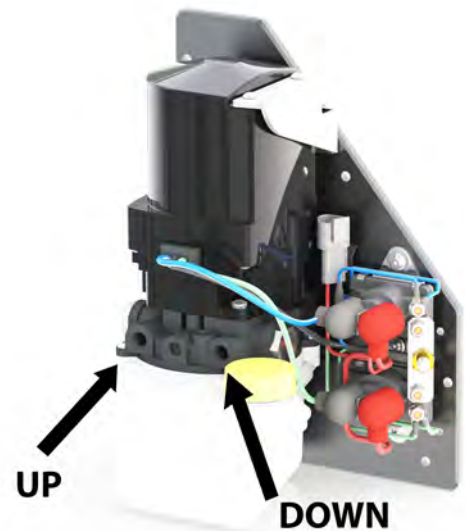

12 VOLT
See page 7 for wiring diagram

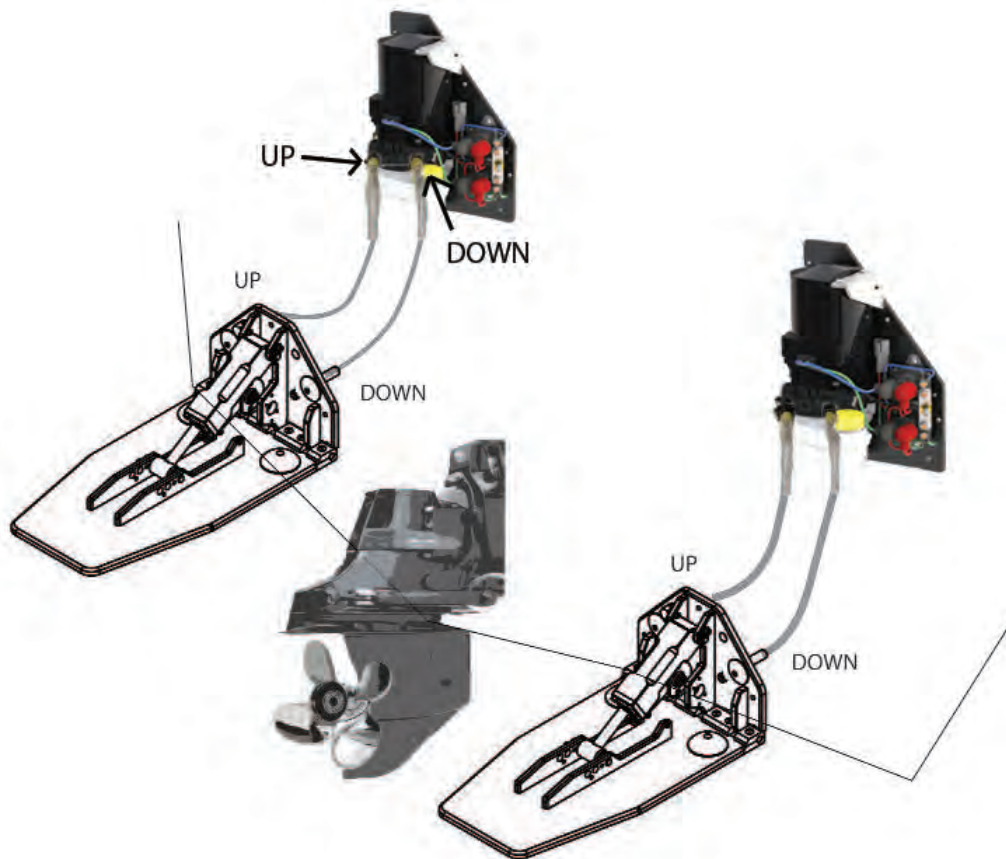

Billet Trim Tab Installation

24 VDC Trim Pump Wiring Diagram

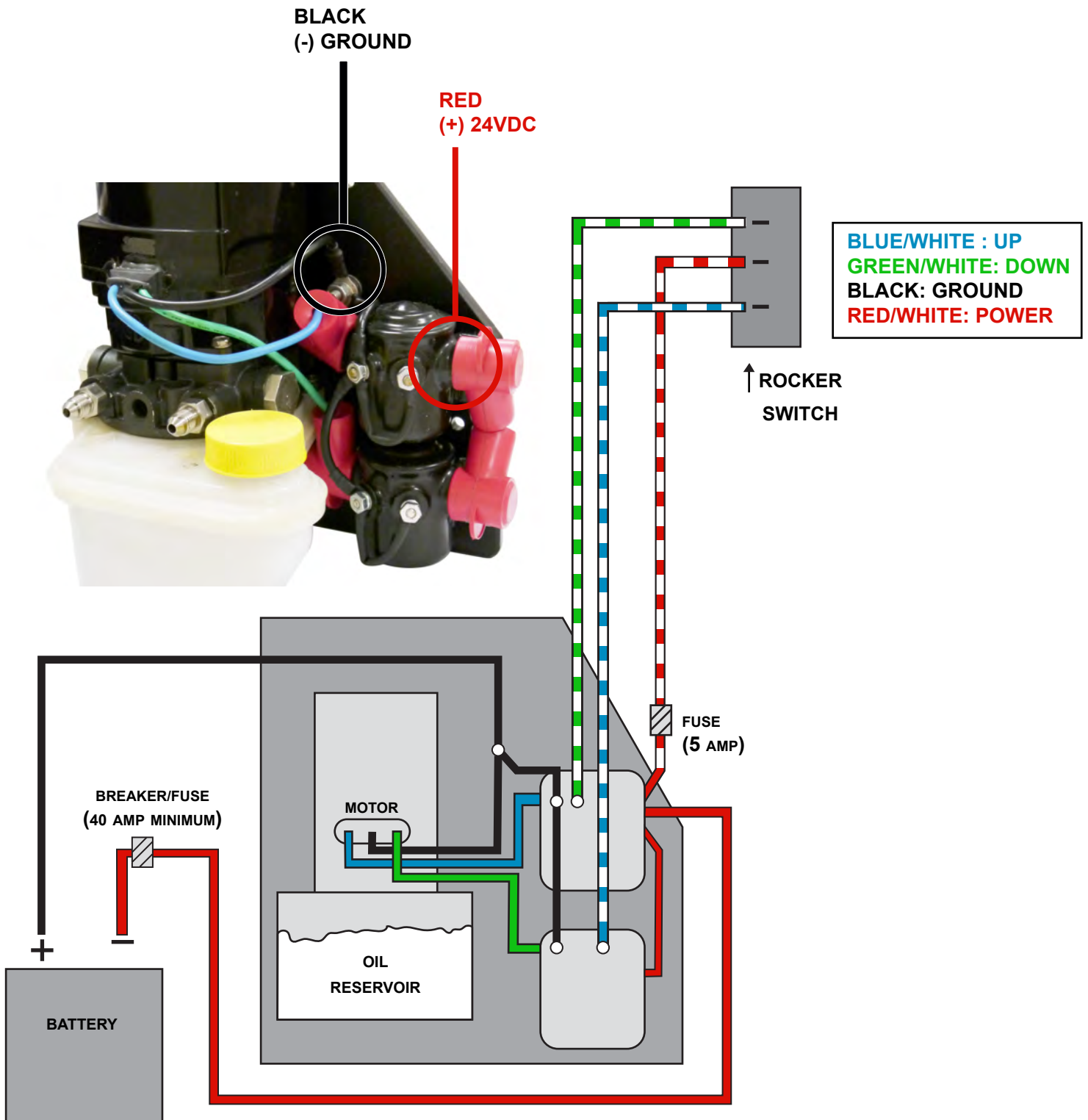

Billet Trim Tab Installation

12 VDC Trim Pump Wiring Diagram

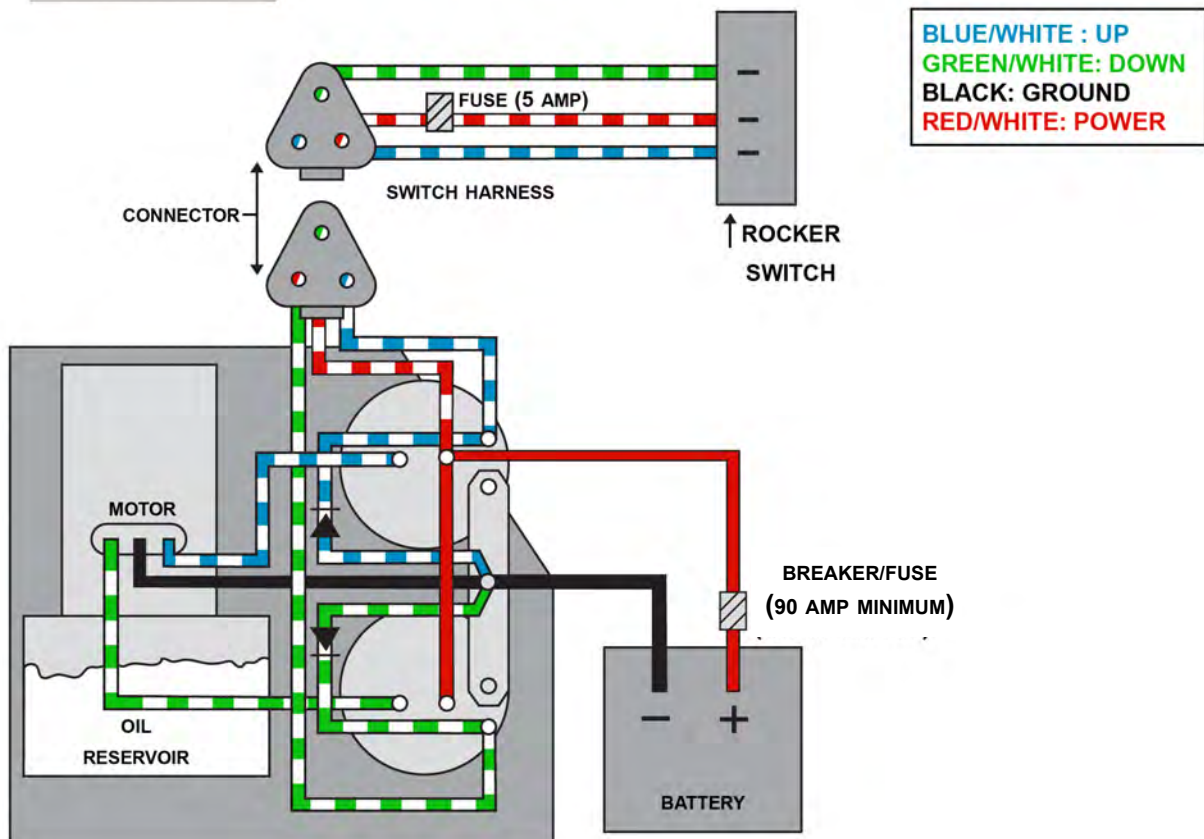
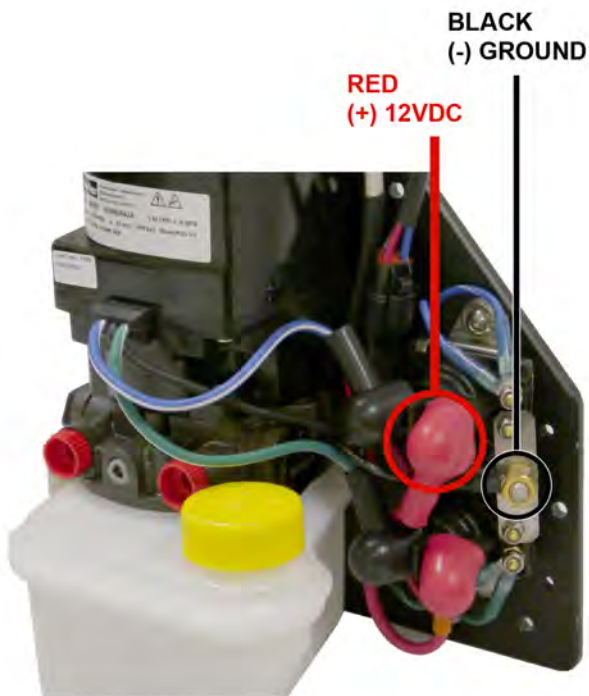

Billet Trim Tab Installation

Sensor Wiring

The sensor wire leads that were fished thru the transom will need to be inserted in to the 6 pin Deutsch connector and secured with a wedge lock. Below is the pin out.

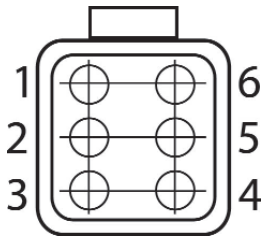

Pin Number	Wire Color	Description
1	Red	PPS1 (5V)
2	White	PPS2 (5V)
3	Blue	PPS1 Signal
4	Black	PPS1 Ground
5	Green	PPS2 Ground
6	Tan	PPS2 Signal



connector wedge lock



sensor wires
from trim tab

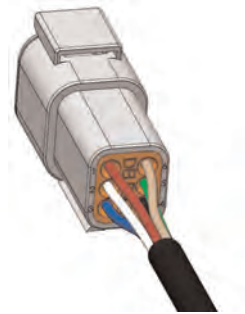

Once pins are pushed thru the connector, insert the wedge lock to secure pins.

The “arm” of the wedge lock should face the same side as the connector clasp.

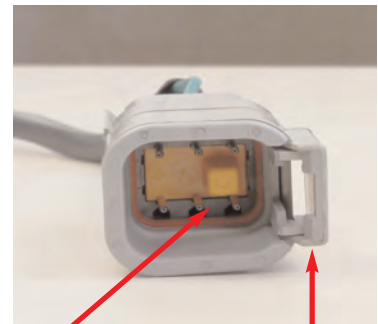

wedge “arm”

connector clasp

Billet Trim Tab Installation

Connections directly to LED Indicator

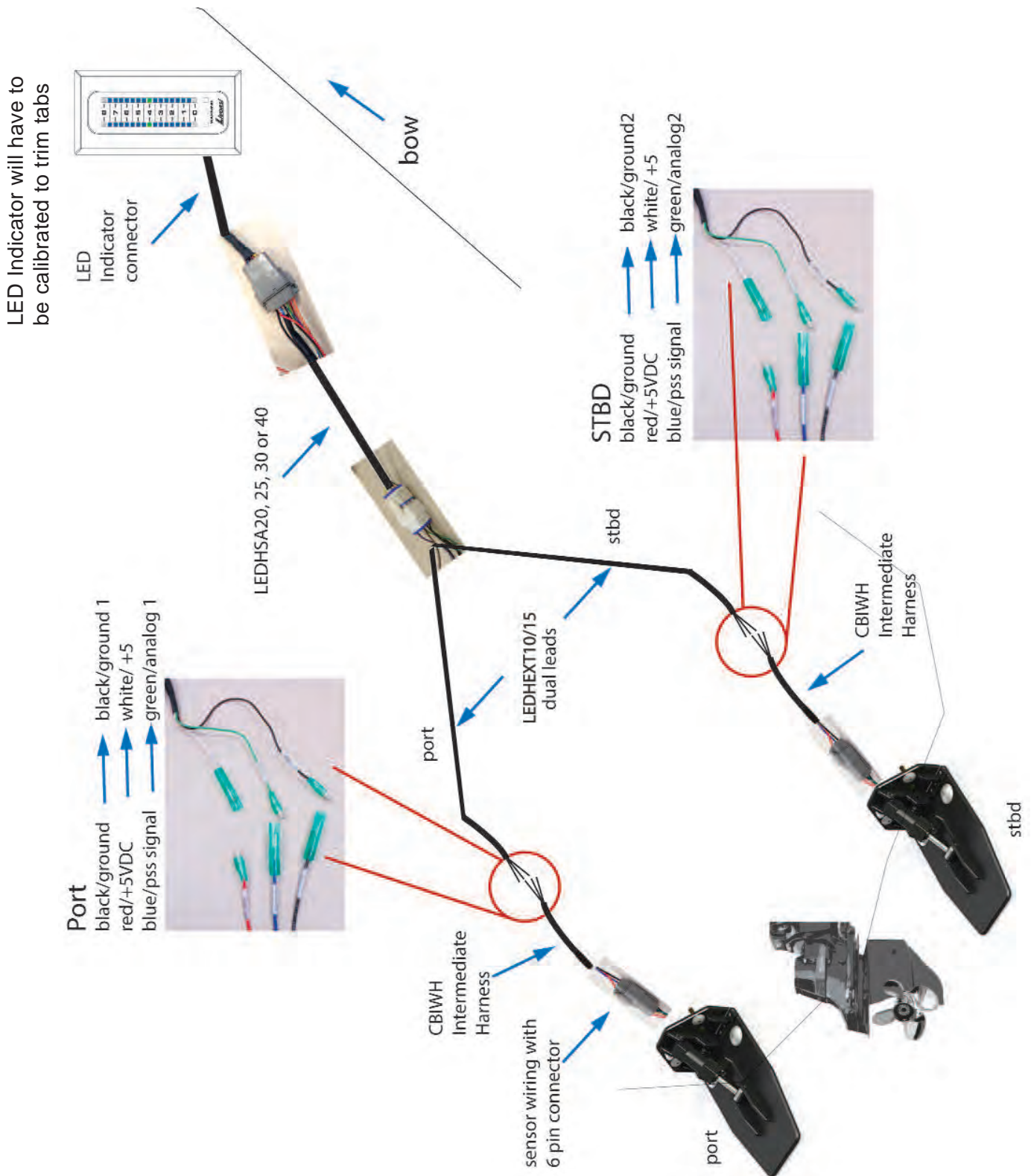

Billet Trim Tab Installation

Connections to a Mercury VesselView®

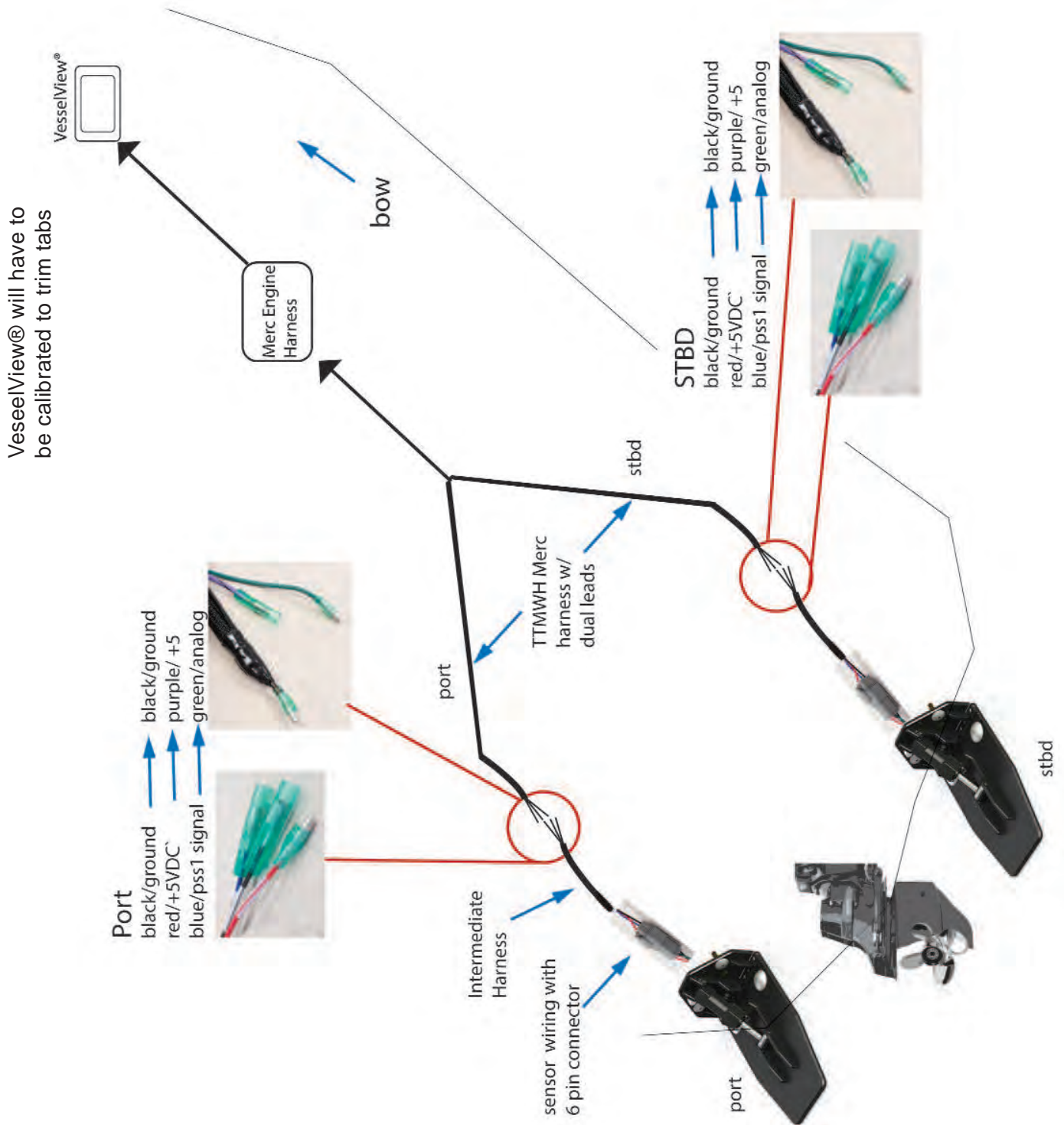

Billet Trim Tab Installation

Fill the pump with oil:

The pump reservoir has markers indicating the maximum and minimum oil levels.

The operating temperature and the oil used will determine the reaction speed of the tabs.

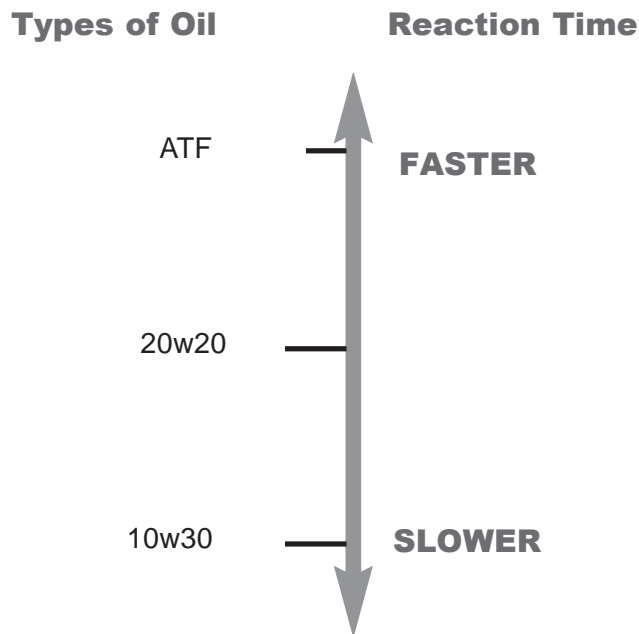
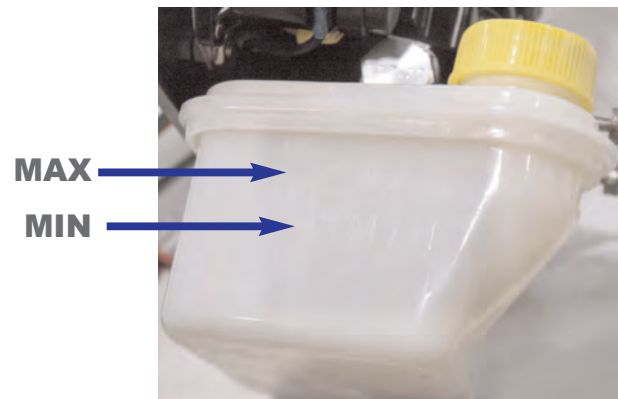

Testing:

The hydraulic system will be full of air, the system is designed to self purge this air when the tabs are raised and lowered.

Purging Air

Before testing the system ensure the pump is filled with oil to the MAX level line.

To purge, fully raise and fully lower the tabs 3X times.

Check the oil level and inspect all hydraulic components for leaks.

Repeat fully raising and fully lowering of the tabs until operation is smooth.

NOTE: While purging the oil will foam (inducing air), allow to sit for 24 hours, fill as needed.

Billet Trim Tab Installation

Check all hydraulic fittings for leaks

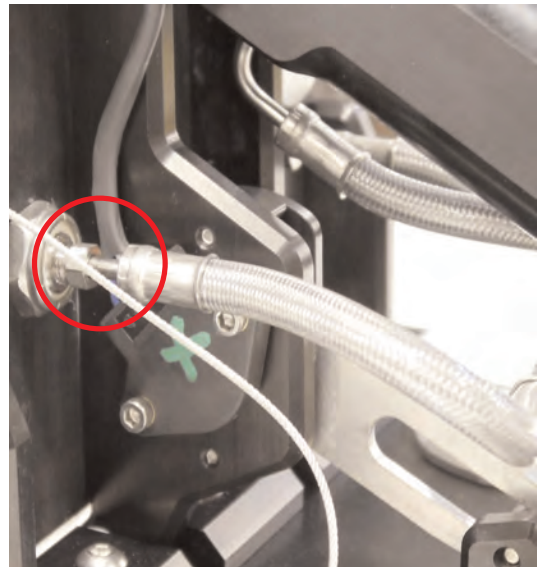
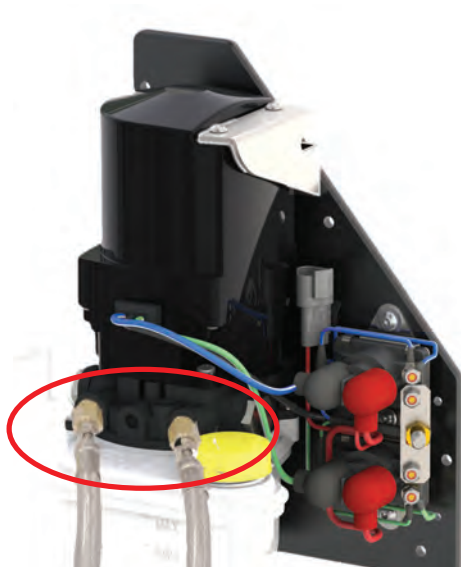
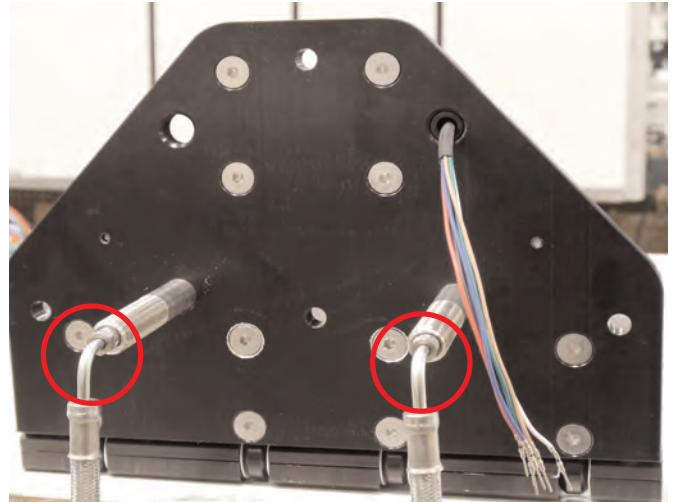
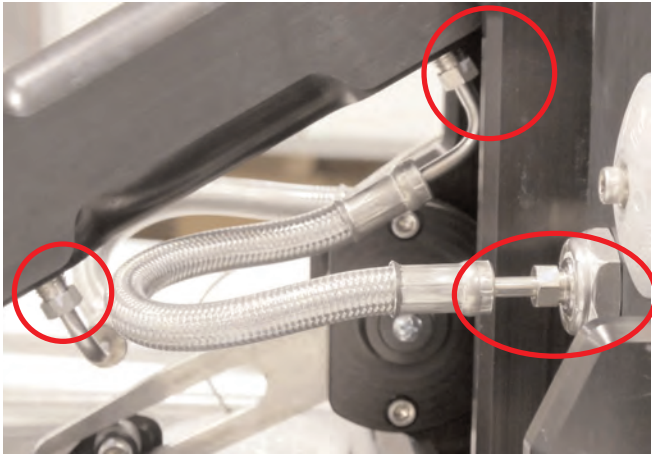

90° Transom Angle

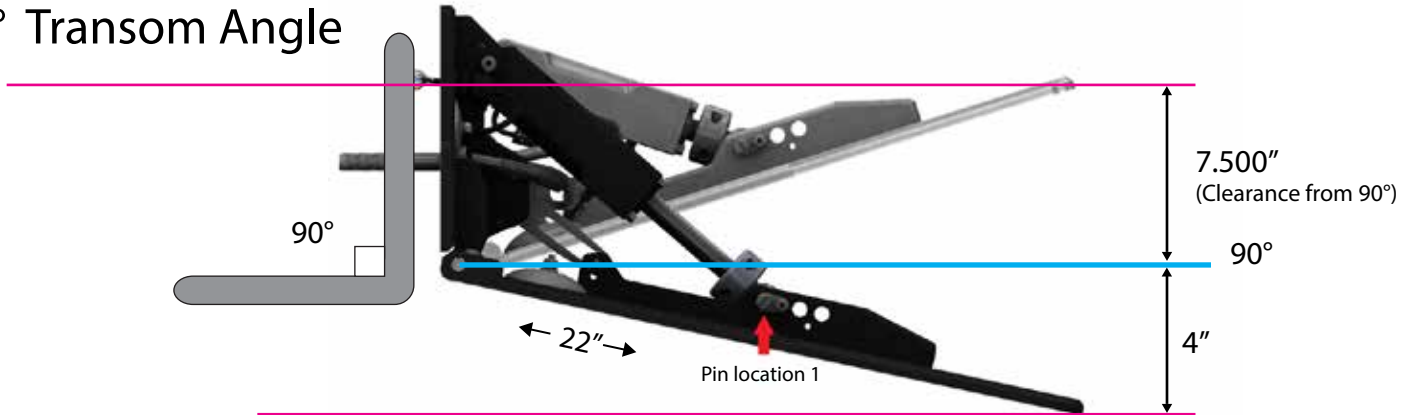

5° Transom Angle

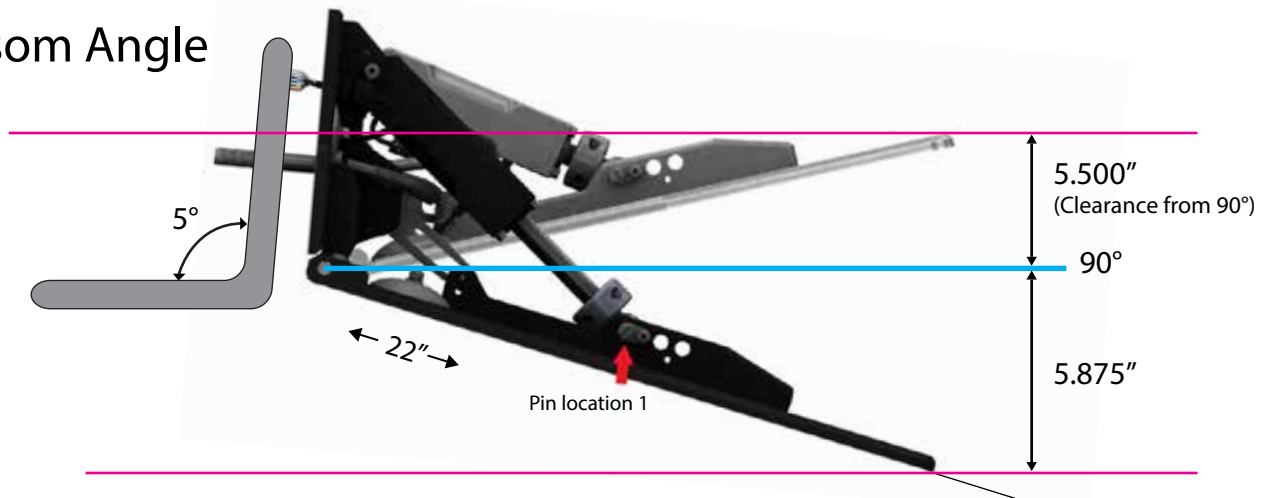

12° Transom Angle

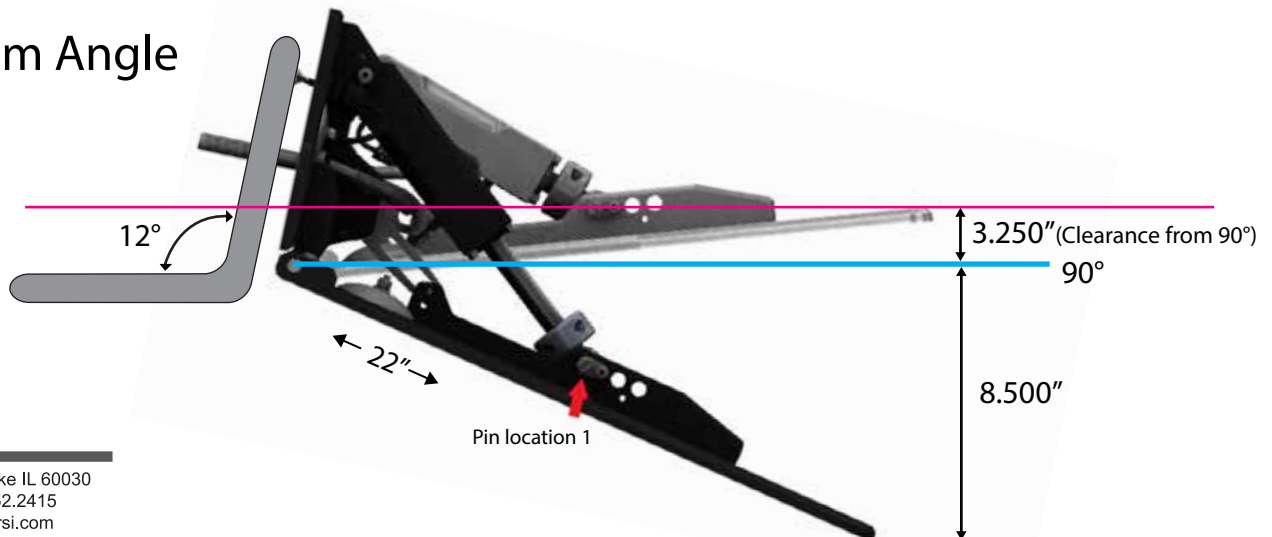

1050 Trim Tab Angles - Pin location 2

For reference only

90° Transom Angle

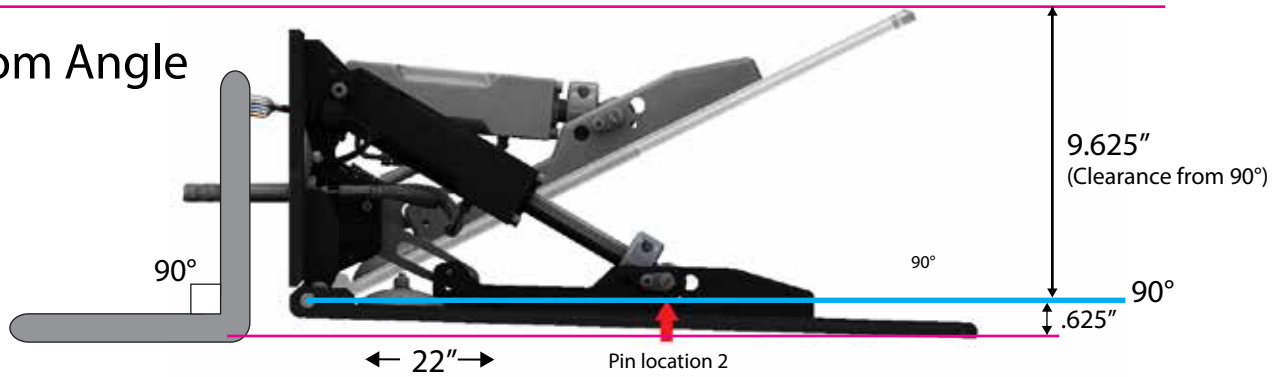

5° Transom Angle

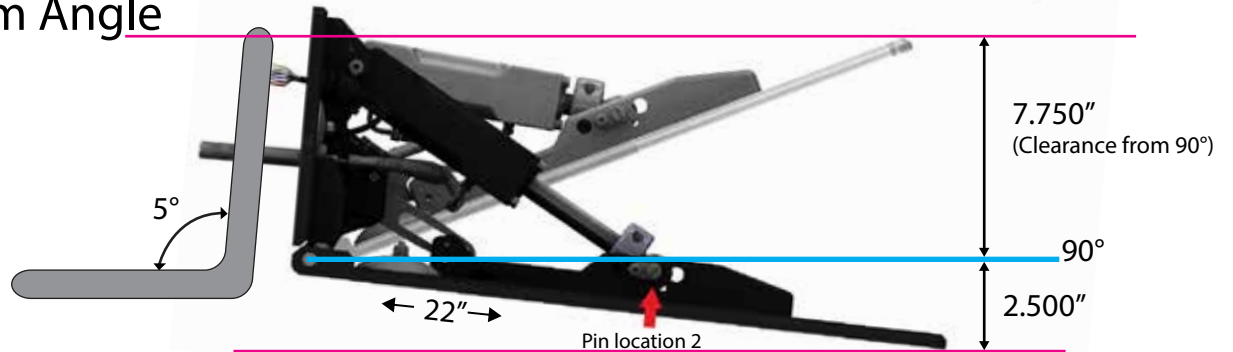

12° Transom Angle

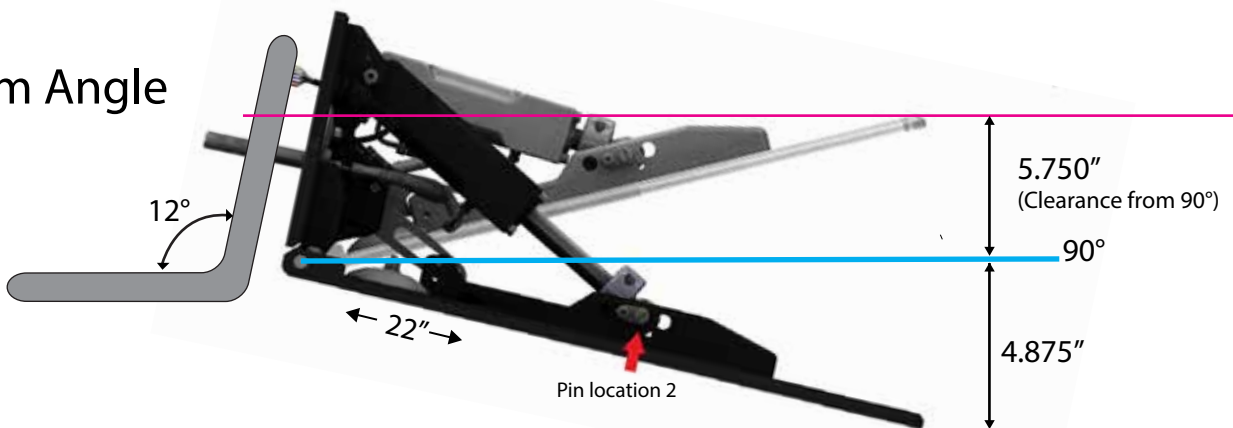

90° Transom Angle

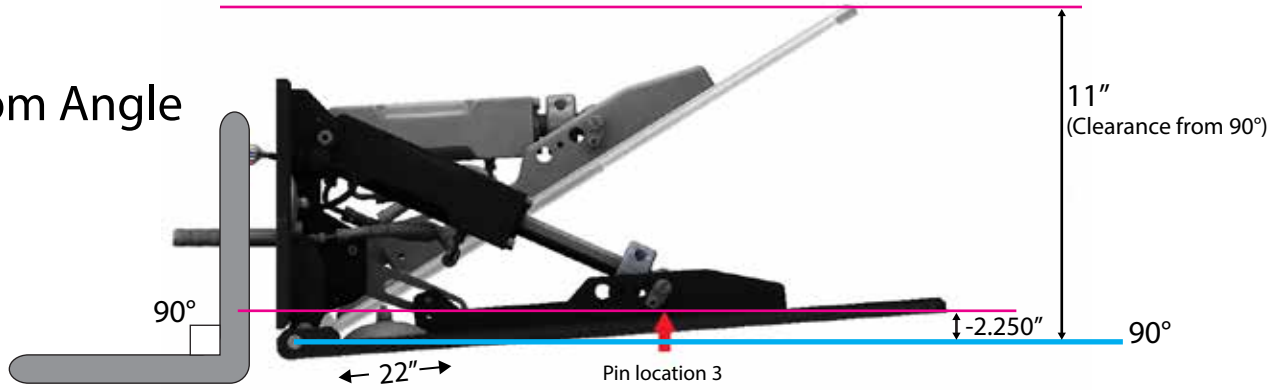

5° Transom Angle

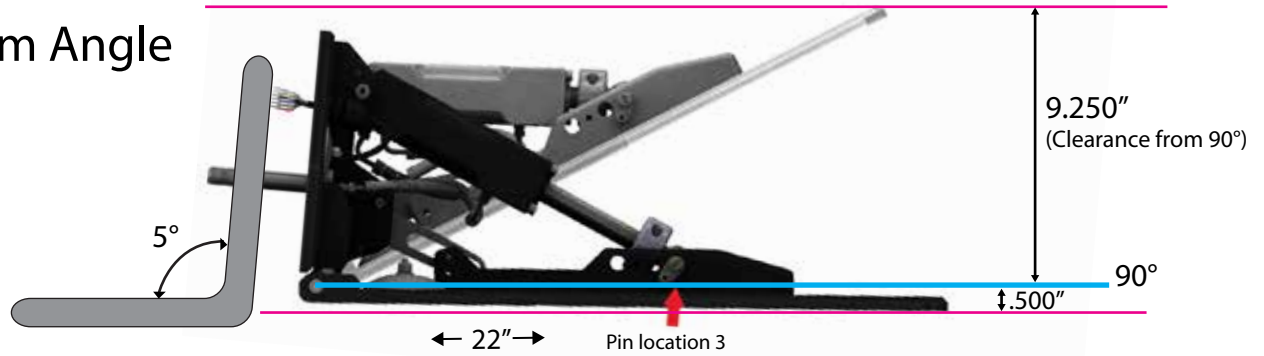

12° Transom Angle

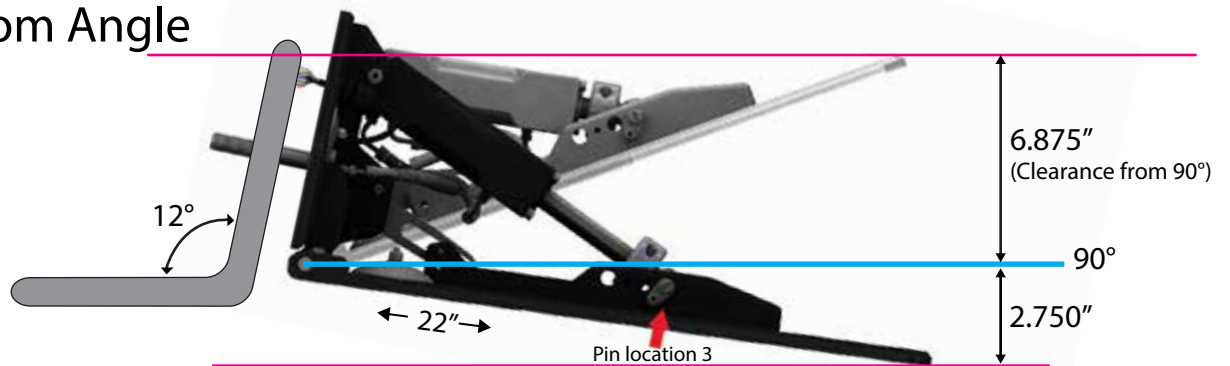

1050 Trim Tab Dimensions

